

Datasheet

SFP Optical Transceiver Product Features

- 1000BASE-ZX Ethernet 41dB SFP
- 200 km ZX SFP for SMF @ 1.25Gbps
- 1270nm - 1610nm DFB+APD Laser 200 km SFP
- 0°C - 70°C Temperature - Extended/Industrial Available
- 2-Wire Interface Digital Diagnostic Monitoring (SFF-8724)
- Hot-swappable for SFP LC ports
- OptoSpan 1 year standard warranty
- Use with Finisar, Avago, JDSU & networks not requiring OEM compatibility
- SFP MSA / IEEE Std 802.3
- RoHS compliant

* For OEM Compatibility, use Platinum Series Part# PSFP-11DCXXK200

SFP-11D-K200CXX



Applications

- 1.25Gbps Gigabit Ethernet
- Fibre Channel 1x
- Other Optical Links

Description

OptoSpan SFP-11D-K200CXX is a CWDM 1000BASE-ZX Ethernet SFP transceiver designed for long distance optical communications up to 200 km with signaling rates up to 1.25Gbps.

OptoSpan 1Gb CWDM optical transceivers are compatible with many brands such as Finisar, Avago, JDSU and network environments that do not require any special compatibility. For networks that require special OEM compatibility, such as CISCO, BROCADE, JUNIPER, ALCATEL, HP, NORTEL, EMC, QLOGIC and other OEMs, consider OptoSpan Platinum OEM Series transceiver model# PSFP-11DCXXK200.

All OptoSpan long-reach SFP s are ROHS compliant, allow for real-time diagnostic monitoring as per SFF-8472 and designed to meet Multi-Source Agreement (MSA) standards for CWDM transceivers with LC interface.

Optical Budget Calculation for 200 km SFP Optical Transceiver

SFP- 11D-K200CXX	Distance: 200 km				Fiber: 1270nm - 1610nm	
	Tx Min dBm	Tx Max dBm	Rx Min dBm	Rx Max dBm	Link Attenuation dB	Power Budget dB
Product Specifications	4	7	-37	-10		
Optical Calculation Results			-36.6	-33.6	40.6	41



SFP CWDM 200 km transceiver | 1G ZX Ethernet

General Specifications

Parameter	Unit	Min.	Typ.	Max
Absolute Maximum Ratings				
Maximum Supply Voltage	V	-0.5		3.6
Storage Temperature	°C	-40		+85
Case Operating Temperature	°C	0		+70
Recommended Operating Condition				
Supply Voltage	V	3.15	3.3	3.45
Supply Current	mA			300
Data Rate	Gbps		1.25	

Electrical Characteristics

Parameter	Unit	Min.	Typ.	Max
Transmitter				
Differential Input Voltage Swing	mVpp	400		2000
Input Differential Impedance	ohm	85	100	115
Transmit Disable Voltage - High	V	2		Vcc+0.3
Transmit Disable Voltage - Low	V	0		0.8
Transmit Fault Voltage - High	V	2		Vcc+0.3
Transmit Fault Voltage - Low	V	0		0.8
Receiver				
Differential Output Voltage Swing	mVpp	400		2000
Differential Output Impedance	ohms	85	100	115
LOS Output Voltage - High	V	2		Vcc+0.3
LOS Output Voltage - Low	V	0		0.8

Optical Characteristics

Parameter	Unit	Min.	Typ.	Max
Transmitter				
Output Optical Power	dBm	4		7
Optical Extinction Ratio	dB	8.2		
Optical Wavelength	nm	$\lambda_c - 6$	λ_c	$\lambda_c + 7.5$
Spectral Width	nm			1
Side Mode Suppression Ratio	dB	30		
Receiver				
Optical Center Wavelength	nm	1260		1630
Receiver Sensitivity @ 1.25Gbps	dBm	-37		-10
LOS DE-Assert	dBm			-38
LOS Assert	dBm	-45		

Laser Safety

This is a class 1 Laser Product according to IEC 60825-1:1993:+A1:1997+A2:2001. This product complies with 21 CFR 1040.10 and 1040 except for deviations pursuant to Laser Notice No. 50, dated July 26, 2001.

PIN Layout

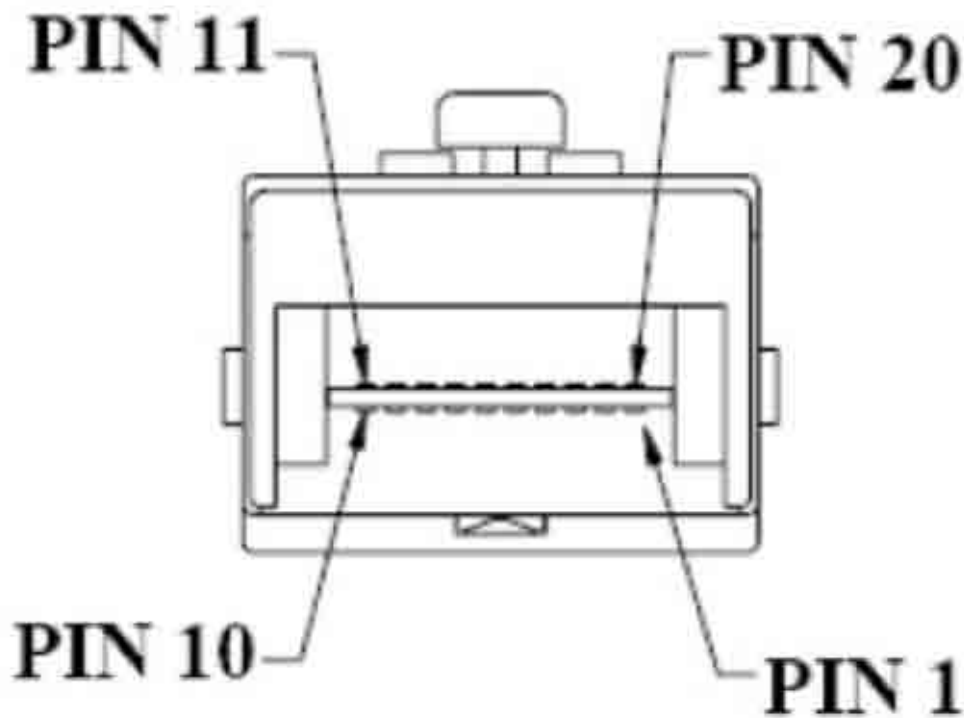
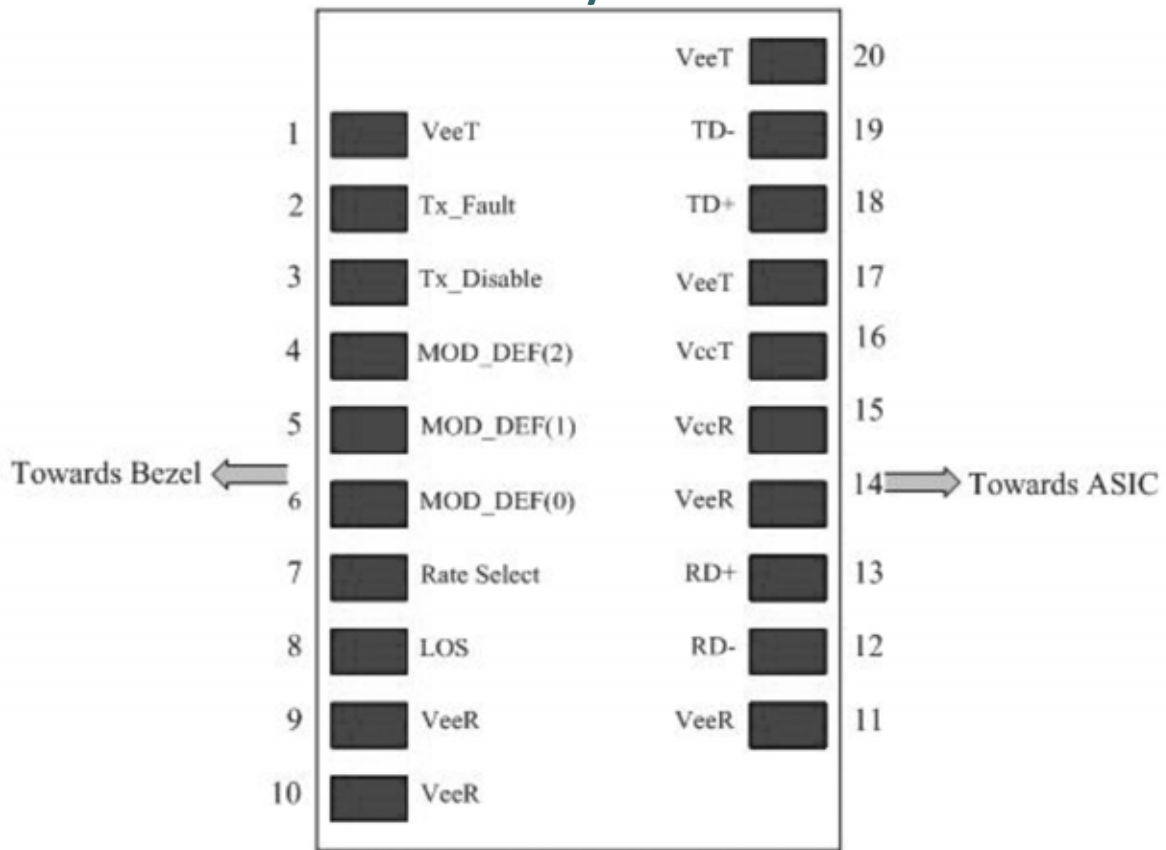



SFP CWDM 200 km transceiver | 1G ZX Ethernet
PIN Functions

Pin #	Name - Description
1	Transmitter Ground
2	Transmitter Fault Indication
3	Transmitter Disable
4	Module Definition 2
5	Module Definition 1
6	Module Definition 0
7	Not Connect
8	Loss of Signal
9	Receiver Ground
10	Receiver Ground
11	Receiver Ground
12	Inv. Received Data Out
13	Received Data Out
14	Receiver Ground
15	Receiver Power
16	Transmitter Power
17	Transmitter Ground
18	Transmit Data In
19	Inv. Transmit Data In
20	Transmitter Ground
21	
22	
23	
24	
25	
26	
27	
28	
29	
30	

